



Operating instructions for the high pressure calibrator (HPX)



Table of contents

View	3
Notes on the operating instructions	4
1. Description of the device	4
2. General safety warnings	4
3. Operating the HPX calibrator	5
4. Description of the functions	5
5. Menu navigation for calibrators	6
6. Commissioning	6
7. Maintenance / disposal	7
8. Software for calibrators	8
Spare parts and accessories for KELLER pressure calibrators	9
Declaration of conformity	10

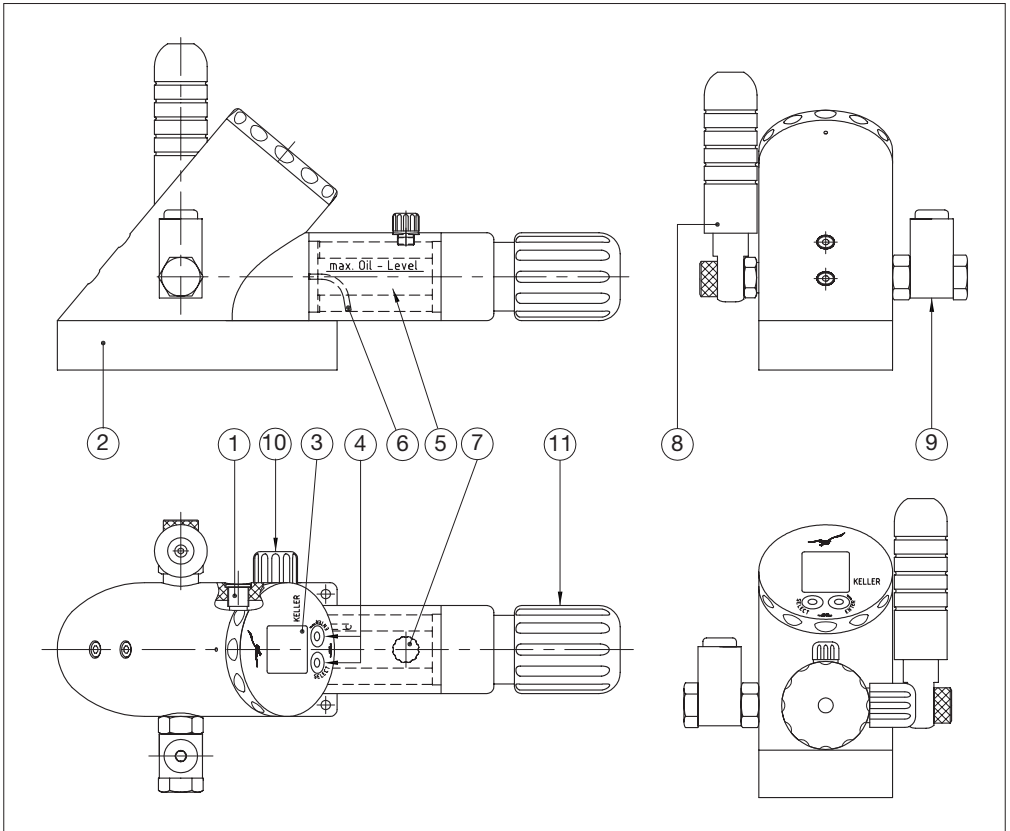

- 1 Port for interface cable (K-104-A or K-114-A)
(PC connection / RS485)
- 2 Device base
- 3 Display
- 4 SELECT and ENTER buttons
- 5 Oil chamber
- 6 Recirculation pipe
- 7 Screwed sealing plug
- 8 Manual booster pump
- 9 Pressure connection for test object, without overpressure valve
(700 bar)
- 10 Drain valve
- 11 Screw compressor

Notes on the operating instructions

- The operating instructions are intended for specialist workers and trained personnel.
- Before each stage of work, read the relevant notes and warnings carefully, and keep to the sequence as stated.
- Pay particular attention to the section on «General safety warnings».

If you have any problems or questions, please contact your supplier or consult KELLER directly.

1. Description of the device

General description

The high pressure calibrator enables pressure to be generated by means of the integrated pressure pump, up to 700 bar relative.

The measurement technology incorporated into this device allows accurate measurement and documentation of the characteristic of a test object that is connected to it. The measured pressure progression can be displayed, evaluated and saved with a computer monitoring program (CCS30).

The calibrator is operated with the two function buttons SELECT and ENTER, located directly below the display. The calibrator itself is powered by a 3,0 V battery, but power can also be supplied externally via the K-114-A interface converter. Test objects (transmitters or pressure switches) must be supplied from an external source.

Pressure range for the display

High pressure calibrators are themselves calibrated with the ambient air pressure as the zero point reference. The Zero function (Set Zero) allows any desired pressure value to be set as the new zero point reference.

To reset the pressure zero point to the factory setting, use the RES Zero function (reset zero).

Commissioning

A pressure-resistant connection for the test object is required in order to use the high pressure calibrator. The pressure connection for the test object is already screwed to the pressure distributor of the high pressure calibrator so that it is pressure resistant when it leaves the factory, and it must not be dismantled.

Recommended torque for the test object pressure connection: 30 Nm

IMPORTANT!

Nothing must adhere to the surface of the test object (no oil, grease, water, etc). Impurities could pass through the adapter to reach the high pressure calibrator and damage it.

Proof pressure

If the pressure exceeds the measuring range by more than 20 %, the measuring cell or the mechanism of the high pressure calibrator may be destroyed.

Recalibration

The recalibration cycle depends on the conditions of use. Recommended recalibration cycle: 1 year.

Scope of delivery

- 1 calibrator (including oil filling)
- 1 carrying case
- 1 test record (5 points)
- 1 test object adapter G 1/4"–G 1/8"
- 1 test object adapter G 1/4"–G 1/2"
- 1 Allen key
- 1 spare battery, type CR2430 (3,0 V)
- 1 set of operating instructions
- 1 USB interface converter, K-114-A
- 1 KELLER software CD

Intended use

The high pressure calibrator (HPX) may only be used to generate pressure with the type HLP 22 BP hydraulic oil that is supplied with the product. Use of the calibrator with other media will damage it. The operational safety of the device supplied is guaranteed only if it is used as intended. The limit values as stated (see page 19: «Technical data») must never be exceeded.

Before installing the high pressure calibrator, check that it is suitable for your applications.

2. General safety warnings

The current national regulations on accident prevention and workplace



safety must be followed whenever work is carried out. Internal regulations issued by the operator must be followed, even if they are not mentioned in these instructions.

Never use the high pressure calibrator together with an external pressure source.

Do not remove any connected components (e.g. test objects) when the high pressure calibrator is under pressure. Open the screwed sealing plug before removing parts.

Do not use Teflon tape to seal the pressure connection. Residues of Teflon tape could penetrate the high-pressure calibrator and damage it.

Only use the adapters and seals that are available as accessories.

Do not store the calibrator under pressure: only store the high pressure calibrator with the drain valve open.

Avoid the action of force of any kind on the high pressure calibrator and its operating controls.

Do not use high pressure calibrators if they are damaged or faulty.

3. Operating the HPX calibrator

Operating the high pressure calibrator is described starting on page 16.

Connect the test object

You can connect your test object to the high pressure calibrator via the pressure connection (9).

Pressure generation

When using the calibrator, the screwed sealing plug (7) must be opened (2 turns), so that overpressure cannot build up in the oil reservoir.

Use the manual booster pump (8) to set the pressure to about 10 bar. You can use the screw compressor (11) to increase or reduce the pressure.

Release pressure

1. Open the screw compressor (11) **completely**
2. Open the drain valve (10)

IMPORTANT!

Do not open if there is high pressure in the system!

If you can no longer reach the desired pressure, please consult the section on "Maintenance" to find out how to vent the system.

Zeroing the device

Open the drain valve (10) to release any pressure that may have built up. If the pressure display does not show zero, perform a zeroing procedure (Set Zero) and then close the drain valve.

Information about the display

If no pressure can be shown on the display, it will show OFL (overflow) or UFL (underflow).

If pressure outside the device's measuring range is applied, the

last valid pressure value that was measured will flash on the display (overflow warning).

Reset



4. Description of the functions

Menu navigation

If the selected function or unit is not activated by pressing the ENTER button within 5 seconds, the display will return to measuring mode without changing a setting.

Function	Reset	Description
Min. / max. display		Shows the peak and trough pressure values measured thus far. (Display is shown with reduced resolution)
Leak measurement		Leak mode is used to determine the pressure change over a defined period, which can be changed. (Leak measurement period, factory setting: 10 minutes)
Zero the display		Permanently sets the applied pressure as the new pressure zero point.
Reset display		Resets the pressure zero point to the factory setting.
Automatic switch-off function		(Cont = Continuous) The device switches off automatically after a defined period (which can be changed), starting from the last time a button was pressed. (Switch-off period, factory setting: 15 minutes)
Select units		mbar, bar, hPa, kPa, MPa, cmH2O, mH2O, inH2O, ftH2O, PSI, kp/cm ² , mmHg, inHg

SELECT button

The SELECT button positioned on the front is used to switch the device on, to select a function and to select the various pressure units.



ENTER button

The ENTER button positioned on the front is used to activate the selected function or pressure unit on the device. You can also press the ENTER button to switch between the minimum and maximum pressure values measured thus far.

5. Menu navigation for calibrators

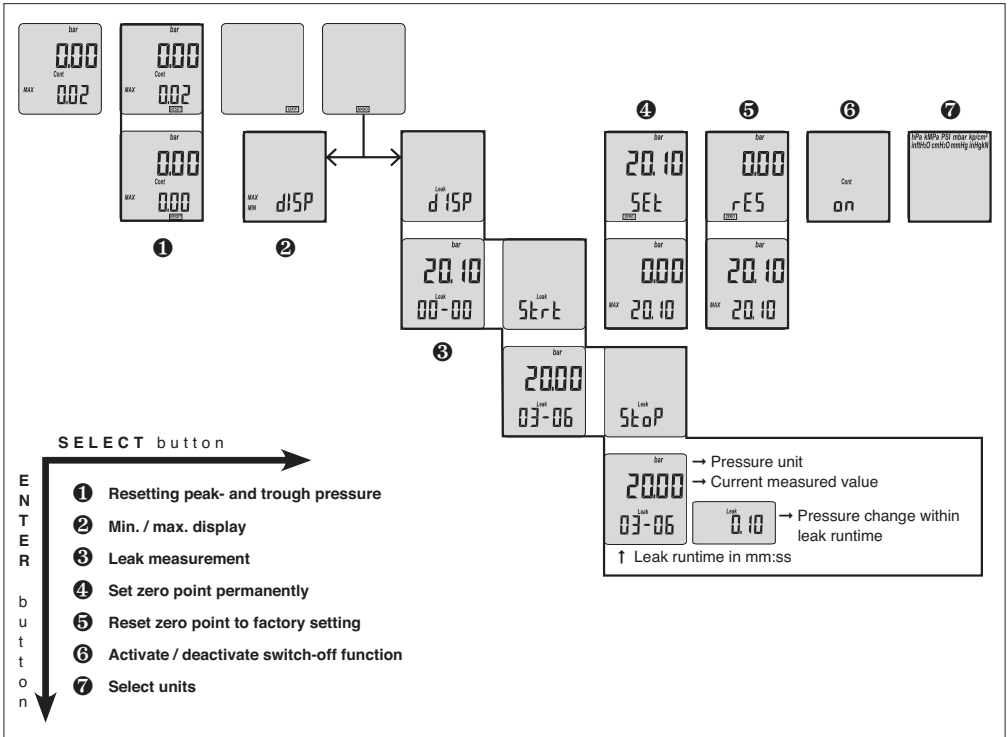

6. Commissioning

Switch the device on

Press the SELECT button to switch the device on. Initially, the device shows the pressure range calibrated in the factory (top) and the software version (year / week).

Switch the device off

Keep the SELECT button pressed down until the display shows OFF.

Press the ENTER button to execute the shutdown.

→ The settings made previously are retained when you switch the device on and off.

Display mode

Display mode is the calibrator's basic mode. The upper part of the display shows the pressure unit and the pressure that is currently measured. The lower part of the display shows the last

function that was used, either the min./max. display or the Leak function.

Using the functions

Written descriptions of the individual functions are given below (in addition to the diagram above).

Selecting functions

The individual sub-functions are called up from the MANO menu. Keep the SELECT button pressed until MANO

is shown, and press ENTER to activate. You can now use SELECT to choose the function you want, and ENTER to execute the function. Depending on the current setting, the first function to be shown is either min/max disp or LEAK disp.

Leak measurement function

Leak mode is used to determine the pressure change over a defined period, which can be adjusted. The unit to be tested must be connected to the high pressure calibrator on the pressure side.

Start leak measurement

Activate the MANO menu. The display shows Leak dISP. Press the ENTER button and then the SELECT button. Press ENTER to confirm Leak Start. The leak measurement starts, and the display alternates between the current leak time and the pressure change measured thus far.

Active leak measurement

During leak measurement, the lower part of the display alternates each second between the measurement time that has now elapsed [mm:ss] and the pressure change measured thus far.

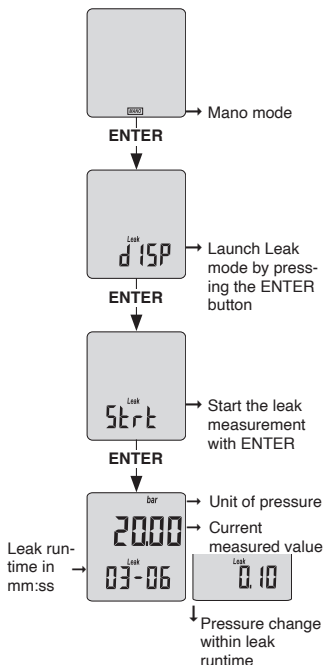

End leak measurement early

To end a leak measurement early, press the ENTER button and confirm the «Leak Stop» display by pressing ENTER.

Leak measurement completed

If the leak measurement time has elapsed or if the measurement was manually ended ahead of time, the display alternates between the elapsed leak measurement time and the measured pressure change.

Set leak measurement time

The leak measurement time is preset to 10 minutes in the factory, and it can only be changed with the «Mano Config» software.

(→ Software for calibrators)

MANO / «Continuous» function

Automatic switch-off function (the device switches off automatically 15 minutes after a button was last pressed). Leak measurements are canceled by the automatic switch-off function if the measurement time is more than the switch-off time.

Cont on: Disables the automatic switch-off function

Cont off: Enables the automatic switch-off function

If the «Continuous» function is enabled, Cont flashes on the display.

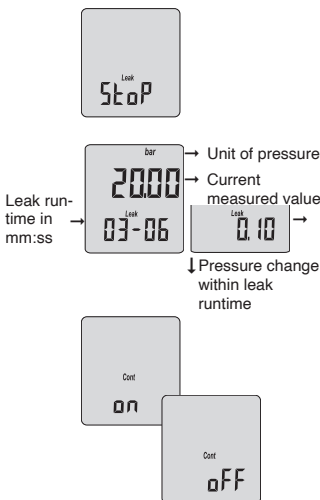

7. Maintenance / disposal

Venting the pressure system

Release the pressure completely and then open the drain valve (10) and the screwed sealing plug (7). Screw the screw compressor (11) in completely. Pump steadily with the manual booster pump (8) to clear the system of air. When no more bubbles come out of the recirculation pipe (6), close the drain valve (10).

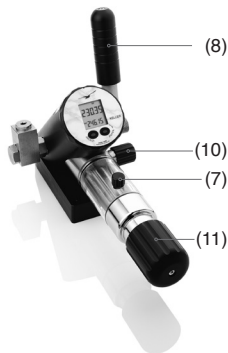

Changing the oil

We recommend that you have KELLER change the oil. The entire system is cleaned at the same time. Only use type HLP 22 BP hydraulic oil.

Battery

The pressure calibrator is powered by a 3 V button-cell battery (behind the display). If the battery is low, the battery symbol on the display **BAT LOW** lights up.

Replacing the battery

Please switch the device off. Turn the display section ring beyond the limit stop until it is released from the housing section (turn through about 180°). Open the battery compartment and change the battery (type CR 2430).

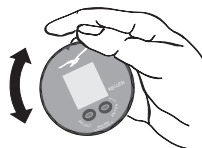

Disposal

This product must not be disposed of as normal household waste at the end of its useful lifetime. To prevent possible damage to the environment or to health due to uncontrolled waste disposal, this product must be separated from other waste and recycled correctly in order to ensure sustainable use of the raw materials.



8. Software for calibrators

The USB interface converter (K-114-A) enables communication between the calibrator and a computer. Before you connect the interface converter to the computer, install driver K-104 / K-114 (the software CD is included in the scope of delivery, K-114-A, or can be downloaded free of charge at www.keller-druck.com)

Settings on the high pressure calibrator with the ManoConfig software

Device settings such as the leak measurement time or the switch-off time for the pressure calibrator can be adjusted using the «ManoConfig» software.

Record measurements with the CCS30 software

The CCS30 software records the data measured by the pressure calibrator, and shows them in both graphic and tabular form. Measured data can be saved or exported for further processing. You will find more information about the software in the CCS30 manual.

Step-by-step software installation

Install from the CD or from www.keller-druck.com:

- 1.) K-104 / K-114 driver
- 2.) (CCS30) Control Center Series 30
- 3.) ManoConfig (if desired)

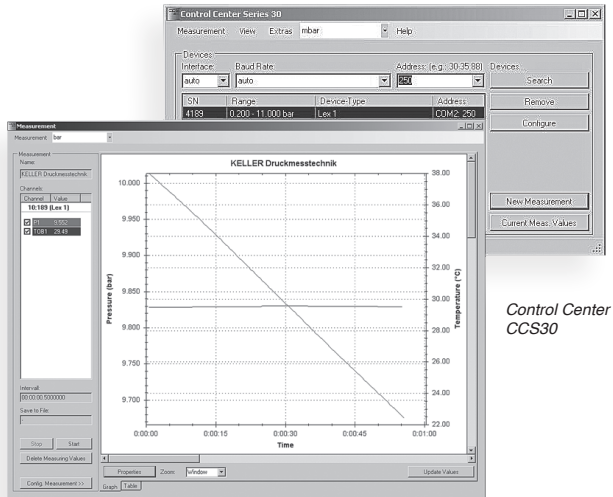



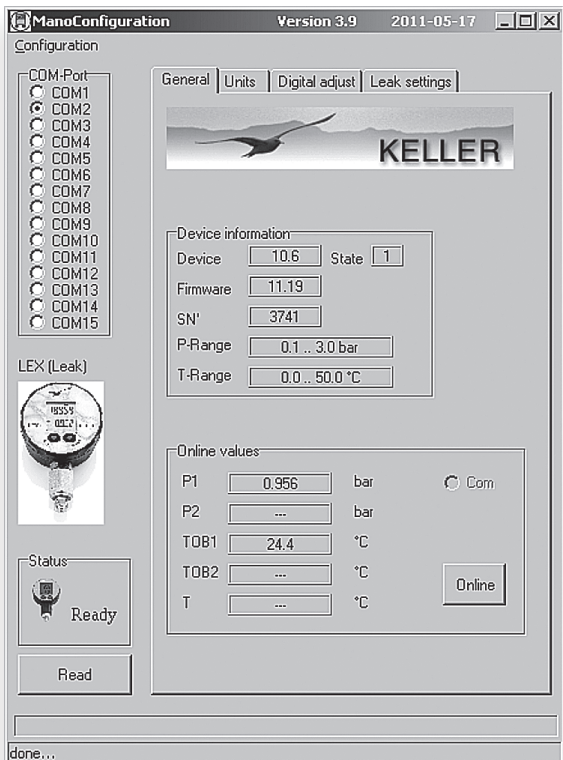











Control Center
CCS30



ManoConfig

Spare parts and accessories for KELLER pressure calibrators

Description	Article number	suitable for			Illustration
		LPX	MPX	HPX	
Carrying case, empty	309025.0005	x	x	x	
Battery, type CR2430	557005.0001	x	x	x	
Hose nipple	508832.0005	x	x		
Connecting nipple, G 1/4" including sealing ring	508832.0004	x	x		
Y-coupler	307025.0001		x		
Test object adapter, G 1/4"M-G 3/8"F	506810.0028			x	
Test object adapter, G 1/4"M-G 1/2"F	506810.0013			x	
Sealing ring, G 1/8"	508635.0001	x	x		
Sealing ring, G 1/4"	508635.0002	x	x		
CrNi filter	307025.2011	x	x		
Vacuum pump	309005.0005	x	x		
Air pump	309005.0016	x			
Fine-tuning valve	307025.2004	x	x		
Bottle of oil, 0,5 l (HLP 22 BP hydraulic oil)	650505.0005			x	
K-114-A	309010.0075	x	x	x	

Für das folgenden Erzeugnis...

**Hochdruckkalibrator
HPX**

wird hiermit bestätigt, dass es den Anforderungen folgender EU-Richtlinien entspricht:

EMV-Richtlinie 2014/30/EU
RoHS-Richtlinie 2011/65/EU und
Delegierte Richtlinie (EU) 2015/863

Dieser Hochdruckkalibrator HPX wurde entsprechend den folgenden Normen geprüft:

Herewith we declare, that the following product or product range

**High pressure
calibrator HPX**

meet the basic requirements, which are established in the guidelines of the European Community:

Directive EMC 2014/30/EU
Directive RoHS 2011/65/EU and
Commission Delegated Directive (EU) 2015/863

As criteria, the following norms for this high pressure calibrator HPX are applied:

Nous attestons que le produit ou gamme de produits :

**Calibreur haute
pression HPX**

répondent aux exigences prévues par les directives de la Communauté Européenne :

Directive CEM 2014/30/UE
Directive RoHS 2011/65/UE et
Directive Déléguée (UE) 2015/863

Le calibreur haute pression HPX répond aux normes:

**EN 61000-6-1:2007 EN 61000-6-2:2005 EN 61000-6-3:2011 EN 61000-6-4:2011
EN 61326-1:2013 EN 61326-2-3:2013**

Diese Erklärung wird verantwortlich für den Hersteller

This declaration is given for the manufacturer:

La présente déclaration est fournie pour le fabricant

KELLER AG für Druckmesstechnik, St. Gallerstrasse 119, CH-8404 Winterthur

abgegeben durch die

in full responsibility by

par

KELLER GmbH, Schwarzwaldstrasse 17, DE-79798 Jestetten

Jestetten, 04. Februar | February | février 2022

Bernhard Vetterli
Leiter Entwicklung | Technical Director
Responsable développement

Matthias Schlimper
Qualitäts Manager | Quality Manager
Responsable qualité



KELLER AG für Druckmesstechnik
St. Gallerstrasse 119 • CH-8404 Winterthur
Tel. +41 52 235 25 25 • Fax +41 52 235 25 00

www.keller-druck.com



 **KELLER**